

30x30x10mm

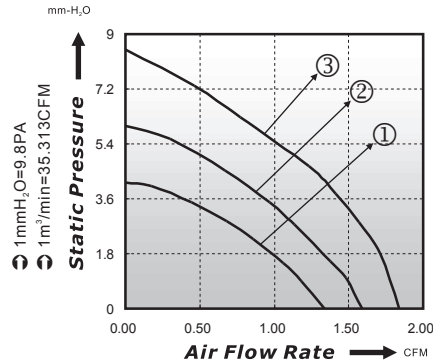

■ P-Q Curve (At Rated Voltage)



■ Dimensions Drawing

Unit: (mm)

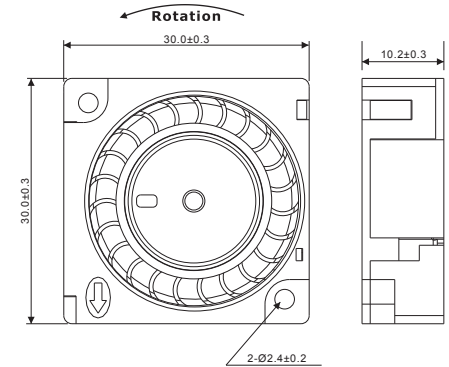

Model No	Bearing (*)	Rated Voltage (VDC)	Rated Current (A)	Power Consumption (Watts)	Speed (rpm)	Air Flow (CFM)	Static Pressure (mmH ₂ O)	Noise (dBA)	Curve
PLB03010B05L	○●⊖	5	0.12	0.60	5500	1.34	4.14	21.7	1
PLB03010B05M	○●⊖	5	0.22	1.10	6500	1.59	6.00	25.1	2
PLB03010B05H	○●⊖	5	0.27	1.35	7500	1.84	8.50	29.5	3
PLB03010B12L	○●⊖	12	0.08	0.96	5500	1.34	4.14	21.7	1
PLB03010B12M	○●⊖	12	0.12	1.44	6500	1.59	6.00	25.1	2
PLB03010B12H	○●⊖	12	0.15	1.80	7500	1.84	8.50	29.5	3

* Bearing Type: ○ Sleeve ▲ One Ball and One Sleeve ● Two Ball ⊖ Hydro-Dynamic